

B150P-9



Doosan 9 Series
High Level Order Picker
3,000 lb. Capacity



www.DoosanLift.com

Your Reliable Partner

Product Features Overview

Advanced Design

Doosan's new 9 Series Order Picker combines innovative safety features, superior performance, and thoughtful ergonomics, making your warehouse operation safer and more efficient.

Intelligent Safety

- Auto Directional Alignment (Key on)
- Electromagnetic Parking Brake
- AC Proportional Lift/Lower Control
- Height and Descent Proximity Sensors
- Safety Side Gate with Electronic Lockout Function
- Battery Side Gate & Hood Cover Safety Interlock
- Doosan GSS (*Guardian Stability System*)
 - › Driving Speed Control
 - › Cornering Speed Control
- Rigid High-Stability Mast
- Chain Slack Sensor
- Emergency Stop Button
- Back-Up Alarm



Outstanding Productivity & Comfort

- LED Lighting & High Performance Operator Fans
- Electric Power Steering
- Three Travel Modes
- Pre-height Selector
- Wide View Mast
- Top-tier Travel and Lift Speeds
- Excellent Operator Comfort
 - › Oversized Cushioned Operator Platform
 - › USB Port and Power Supply
 - › Ergonomically Designed Control Handle
 - › Operator Convenience Add-ons for Scanners, Clip Boards & Cup Holders



Exceptional Reliability

- All AC Curtis Controller
- Industry Proven Prestolite Motors
- Schabmuller Steer Motor
- Reliable ZF Drive Unit
- Heavy-duty Stellana Drive Tire and Load Wheels

Easy Maintenance

- Wide-Opening Tool-free Service Doors
- Easy Access Hood
- Lift Chain Slack Sensor
- Easy Access to Drive Tire
- Quick-Charge Connector
- Easy Access to Hydraulic Pump, Drive Motor & Steering Components
- Extended Maintenance Intervals (2,500-hr. Hydraulic Oil Changes)

Optional Features

- Clear Poly-Carbonate Screen
- Dual Operator Cooling Fans
- Front/Rear Safety Lights
- Freezer/Low Temp Packages
- Fire Extinguisher
- Blue Strobe

Safety First Stability & Control

Rigid Mast Design

Operators can pick without worry thanks to the exceptionally stable mast design.

Maneuver narrow aisles quickly and easily. Introducing Doosan's all new High Level Order Picker, equipped with 'Smart-Tec'.

Stable Mast & Operator Platform

Highly rigid mast channels allow the operator to work comfortably and confidently, increasing productivity.

Height and Descent Proximity Sensors

- Monitors Lifting/Lowering Speed to Minimize Shock when Reaching the End of Lift and Lower Cycles
- Provides Operators with Smooth Transitions
- Hydraulic Accumulator Further Aids in Absorbing Shock

Mast Side Thrust Rollers

Strategically placed side rollers minimize lateral platform movement.

Rail Wear Guide Strips

Mast pads help minimize unintended forward/backward movement of the mast, improving operator safety and comfort.

Pallet Clamp

- Securely Holds Pallet in Place When Engaged
- Accommodates Various Center Stringer Sizes

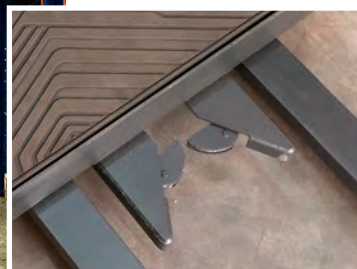

'Smart-Tec' sensors continuously monitor travel speed and lift height to maintain maximum productivity and safety.

Safety Interlock

Multi-point safety interlock functions continuously check the truck's parameters to assure safe operations.

Chain Slack Sensor

Should the chain tension fall outside of the safety parameters, all functions are restricted except for platform lift.

Operator Safety Side Gate

If the safety side gate is raised, all functions except lowering are suspended.

Convenient Foot Switch

All functions are restricted and parking brake is applied automatically when footswitch is not pressed.

Battery Side Gate

Travel is disabled when the battery side gate is not in place.

Rear Door/Hood Sensors

If the sensors detect the doors are open, all truck functions are disabled.

Auto-centering Drive

At start up and after extended inactivity, the steering system is auto-aligned to the forward direction for added safety.

Narrow Aisle Rail Guidance (Option)

Side rollers help the vehicle maintain straight travel. When the side roller is depressed, the drive tire is automatically aligned to neutral until the side rollers are released.

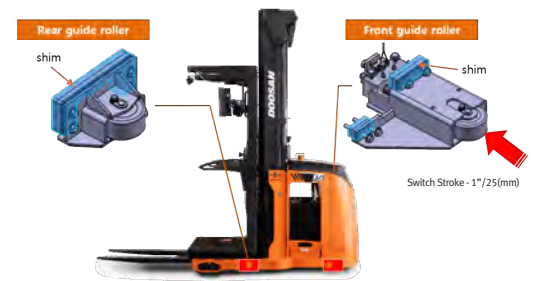

Auto Deceleration

Travel speed is automatically reduced based upon the mast height and steering angle.

Electromagnetic Parking Brake

Automatically applied 3 seconds after truck stops.

Blue Safety Light (Option)

Warning is given to pedestrians by reflecting the blue light in both directions.

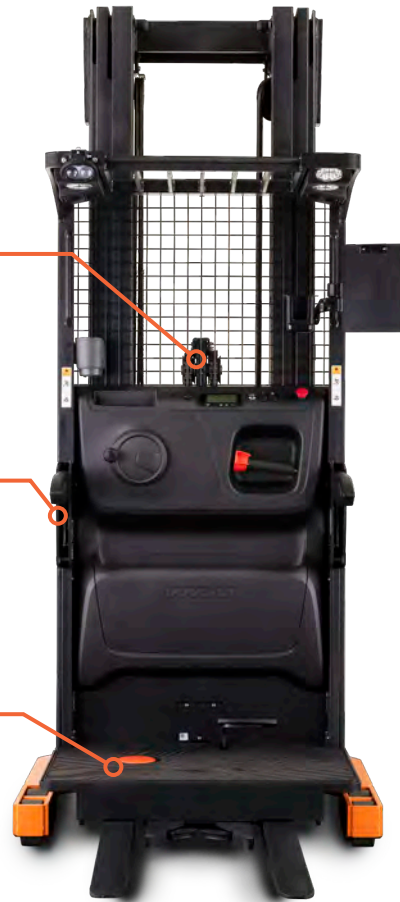

Outstanding Productivity

Power Meets Performance

Fast and Responsive Lifting

The powerful pump motor and reliable AC controller provide efficient lifting and travel speeds, making order picking more productive.



Pre Height Selector

- Pre-set Up to 8 Different Heights
- Automatically Lifts and Stops When the Operator Selects the Desired Setting on the Keypad

The combination of superior power and handling control maximizes performance and improves productivity in a variety of applications.

Doosan's High Level Order Picker
3,000 lb. Capacity

Clear Visibility

Mast layout and cylinder placement is optimized to assure unobstructed forward vision.

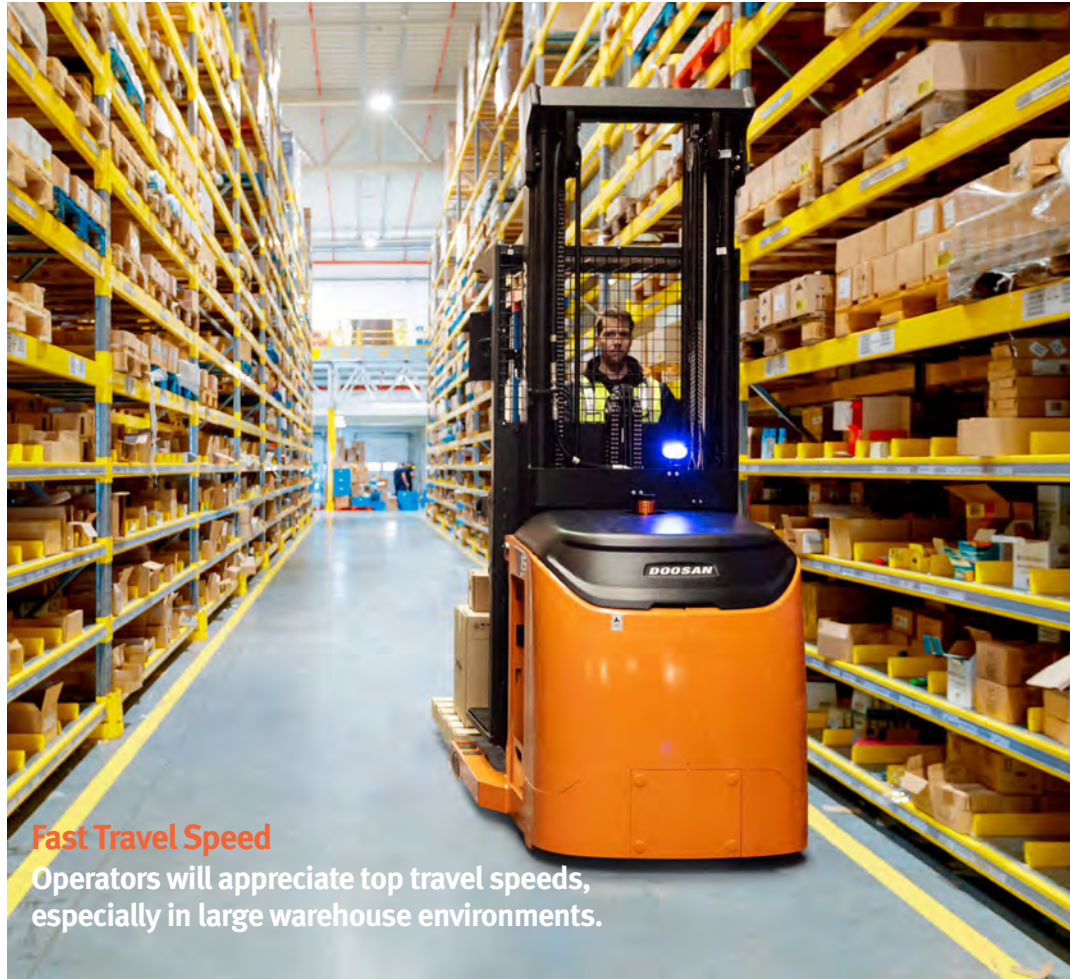

Fast Travel Speed

Operators will appreciate top travel speeds, especially in large warehouse environments.



Bright LED Platform Lights

Operator compartment lighting provides better visibility even in dark operations.



Available in 210"/240"/273" or 300" Mast Heights

Operator Convenience

The Key to Productivity

Convenience



- Operator Cooling Fans**
- High Powered Fan Motors
 - Adjustable Fan Direction
 - Tilted Vent for Improved Air Flow



- Auxiliary Power**
- 5V USB Power
 - 12V Power Jack
 - Cup Holder



Quick-Charge Access Port

Sensor detects the charger's connection and cuts the power to the truck during charging, preventing sudden travel.



Ample Storage

- Upper Compartment for Documents or Small Items
- Lower Compartment for Larger Items



Spacious Operator Platform

- The Doosan 9 Series Order Picker Provides Ample Floor Space for All Operators
- The Large Platform Makes Picking Safer and More Convenient





LED Lighting

Long life LED lights provide increased brightness versus halogen lights.



Accessory Bar for Additional Devices

- Accessory Bars on Both Sides
- Document Clip Board (Optional)
- Scanner Holder (Optional)



Bright and Intuitive Display

Provides quick access to the truck's adjustable performance settings.



Ergonomic Control Handle

- Intentional Design and Placement
- More Natural 8 Degree Hand Position
- Rubber Grip for Anti-slip Control
- Driving/Lifting/Lowering/Horn



Cushion Floor Mat

- Cushion Floor Mat Reduces Fatigue by Absorbing Vibration and Impact
- Surface: Rubber with Anti-skid Pattern
- Inner: PE Foam



Unsurpassed Durability

Reliably Engineered

Extended Service Intervals

- Hydraulic Oil Filter: 2,000 hrs.
- Hydraulic Oil: 2,500 hrs.

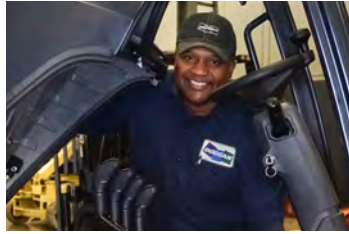

Protected and Enclosed Motors

- Powerful Motors that Ensure Maximum Durability
- IP43 Rated and Enclosed for Increased Protection from Dirt, Dust and Moisture



Reliable AC Controllers

IP65 Rated AC controller is industry proven in various types of applications.



Durable Tire and Load Wheels

- Sturdy Stellana Polyurethane Tires Surpass the Performance Requirements for hHeavy Duty Applications
- Provides Excellent Wear Resistance
- Bolt-on Design for Ease of Maintenance



ZF Transfer

- Patented Hypoid Bevel Gear-set Reduces Heat, Noise and Wear
- No Need for Additional Oil Changes After its First Servicing



Serviceability Simplified Productivity Amplified



Wide Open Rear Door & Hood

Allows ample access to the main components once the rear doors and upper hood are opened.



Central Junction Box

Fuse, relay & controller area network (CAN) ports are centralized for convenient access.

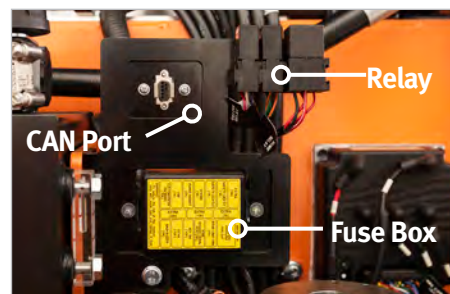

Easy-view Diagnostics

Diagnose the Order Picker and set its performance parameters via laptop (no special tools required).

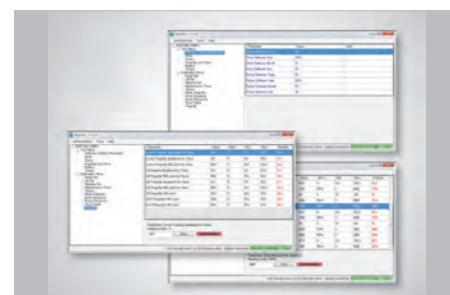

Removable Drive Tire Access Cover

Quick and convenient access to drive tire and drive assembly.

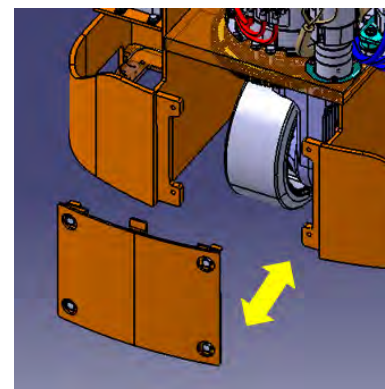

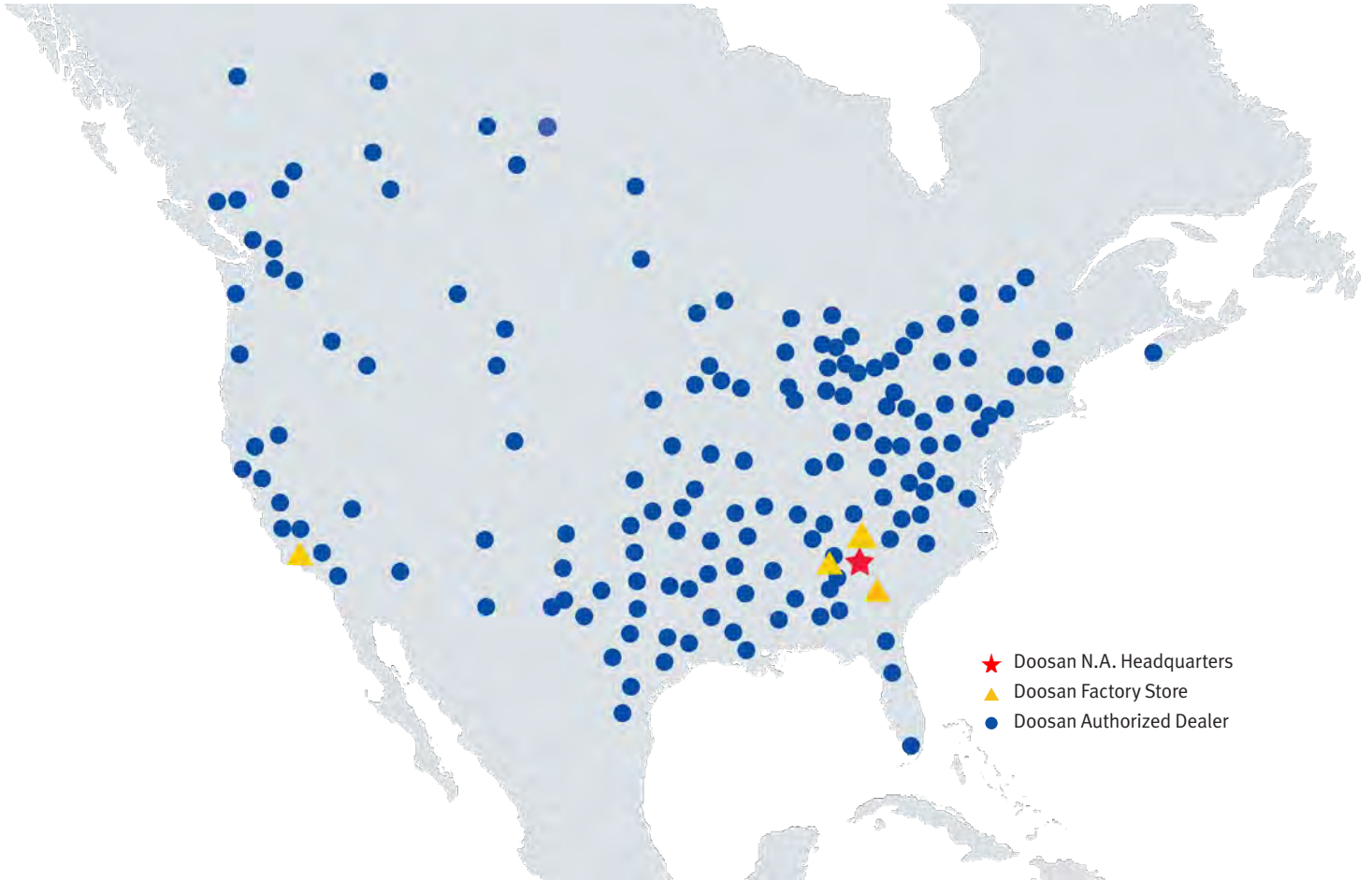

Doosans Extensive North American Dealer Network

Doosan provides superior material handling solutions for your specific needs. From energy efficient electrics to robust internal combustion forklifts, Doosan is your full-line provider.

PSCB150P-9V1



★
Utah
 2640 W. California Ave.
 Salt Lake City, UT 84104
PH (801) 972.1930
FX (801) 972.1964
PH (800) 624.2729

★
Idaho - Nampa
 1905 Madison Avenue
 Nampa, ID 83687
PH (208) 466.8994
FX (208) 466.0466
PH (800) 327.7741

★
Idaho - Idaho Falls
 3441 N. 25th E., Ste 106
 Idaho Falls, ID 83401
PH (208) 475.1850
FX (208) 466.0466
PH (800) 327.7741

★
Idaho - Twin Falls
 2354 Eldridge Avenue
 Twin Falls, ID 83301
PH (208) 475.1828
FX (208) 466.0466
PH (800) 327.7741